

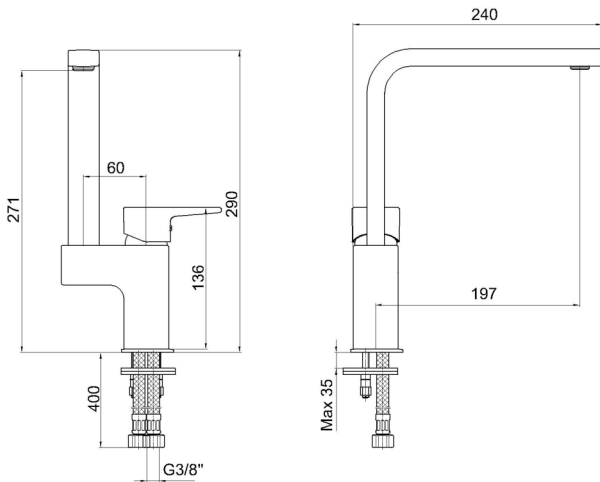

Product Description	
Product Number	102118143EX
Product Name	Sink Mixer

Technical Specification	
Aerator	Neoperl Slim Air PCA
Cartridge Type	Ø35 mm Ceramic Cartridge
Min. Water Pressure	0,5 bar
Max. Water Pressure	10 bars
Recommended Water Pressure	3 bars
Nominal Flow Rate @3bars	6,3 l/m
Inlet Water Temperature	5°C - 65°C
Supply Connection	450 mm G 3/8" Flexible Connection Hoses
Finishing	Chrome
Body Material	Brass



Product Variants	
102118143STEX	Sink Mixer Water Saving 5 l/m
102118143xx	xx Localization Product Number

Flow Rate Chart

